







SK-50  
I İKLİK S STEM  
(Skylight System)

TAM ÖLÇEKL ALÜM NYUM PROF LLER  
(Full Scale Aluminum Profiles)

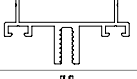
PROF L KES T PROFILE SECTION	PROF L KODU PROFILE CODE	PROF L ADI PROFILE NAME	Jx cm <sup>4</sup>	Jy cm <sup>4</sup>	A IRLIK (kg/m) WEIGHT
	5008	DÜ EY PROF L VERTICAL PROFILE	29,72 cm	15,37	1,596
	5013	YATAY PROF L TRANSOM PROFILE	10,22	9,86	1,150
	5112	DÜ EY YATAY PROF L VERTICAL PROFILE	4,39	0,89	0,617
	5108	DÜ EY PROF L VERTICAL PROFILE	23,97	15,63	1,585
	5109	DÜ EY PROF L VERTICAL PROFILE	27,06	12,57	1,653
	5110	DÜ EY KAPAK PROF L VERTICAL CAP PROFILE	-	-	0,390
	5111	YATAY KAPAK PROF L TRANSOM CAP PROFILE	-	-	0,429
	5046	KAPAK PROF L CAP PROFILE	-	-	0,334
	5047	KAPAK PROF L CAP PROFILE	-	-	0,369
	5048	KAPAK ALTI PROF L CAP UNDER PROFILE	-	-	0,466
	7619	KAPAK ALTI PROF L CAP UNDER PROFILE	-	-	0,337
	5124	KAPAK ALTI PROF L CAP UNDER PROFILE	-	-	0,430
	5058	CAM ALTI TAKOZ PROF L GLASS UNDER WEDGE PROFILE	-	-	0,244

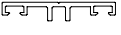
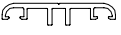
AKSESUAR ACCESSORY	STOK KODU REFERENCE CODE	AKSESUAR ADI DESCRIPTION	AKSESUAR KODU PRODUCT CODE	PAKET PACK
	03 010103	CEPHE CAM F T L GLASS GASKET	CF.03 (3 MM)	165 mt / paket 10 kg
	03 010104	CEPHE CAM F T L GLASS GASKET	CF.04 (4 MM)	145 mt / paket 10 kg
	03 010105	CEPHE CAM F T L GLASS GASKET	CF.05 (5 MM)	120 mt / paket 10 kg
	03 010116	CEPHE CAM F T L GLASS GASKET	CF.06 (6 MM)	105 mt / paket 10 kg
	03 010107	CEPHE CAM F T L GLASS GASKET	CF.07 (7 MM)	95 mt / paket 10 kg
	03 010108	CEPHE CAM F T L GLASS GASKET	CF.08 (8 MM)	85 mt / paket 10 kg
	03 010109	CEPHE CAM F T L GLASS GASKET	CF.09 (9 MM)	80 mt / paket 10 kg
	03 011010	CEPHE CAM F T L GLASS GASKET	CF.10 (10 MM)	75 mt / paket 10 kg
	03 011011	CEPHE CAM F T L GLASS GASKET	CF.11 (11 MM)	70 mt / paket 10 kg
	03 010112	CEPHE CAM F T L GLASS GASKET	CF.12 (12 MM)	65 mt / paket 10 kg
	03 010114	CEPHE CAM F T L GLASS GASKET	CF.14 (14 MM)	165 mt / paket 10 kg

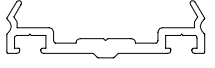
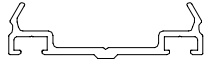
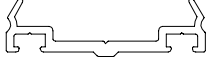
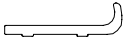
AKSESUAR ACCESSORY	STOK KODU REFERENCE CODE	AKSESUAR ADI DESCRIPTION	AKSESUAR KODU PRODUCT CODE	PAKET PACK
	03 010115	CEPHE CAM F T L GLASS GASKET	CF.15 (15 MM)	145 mt / paket 10 kg
	03 015569	CEPHE ORTA BASKI F T L CENTER PRESSURE GASKET	MF.04 (4 MM)	180 mt / paket 10 kg
	03 015570	CEPHE ORTA BASKI F T L CENTER PRESSURE GASKET	MF.05 (5 MM)	150 mt / paket 10 kg
	03 015565	CEPHE ORTA BASKI F T L CENTER PRESSURE GASKET	MF.06 (6 MM)	130 mt / paket 10 kg
	03 015568	CEPHE ORTA BASKI F T L CENTER PRESSURE GASKET	MF.07 (7 MM)	120 mt / paket 10 kg
	03 010733	CEPHE ORTA BASKI F T L CENTER PRESSURE GASKET	MF.08 (8 MM)	110 mt / paket 10 kg
	03 015566	CEPHE ORTA BASKI F T L CENTER PRESSURE GASKET	MF.09 (9 MM)	100 mt / paket 10 kg
	03 011230	Ç CAM F T L INNER GLAZING GASKET	CF.30	280 mt / paket 10 kg
	03 010606	KAPAK ALTI DI CAM F T L GLASS GASKET	KF.30 (3 MM)	135 mt / paket 10 kg
	03 010607	KAPAK ALTI DI CAM F T L GLASS GASKET	KF.50 (5 MM)	105 mt / paket 10 kg

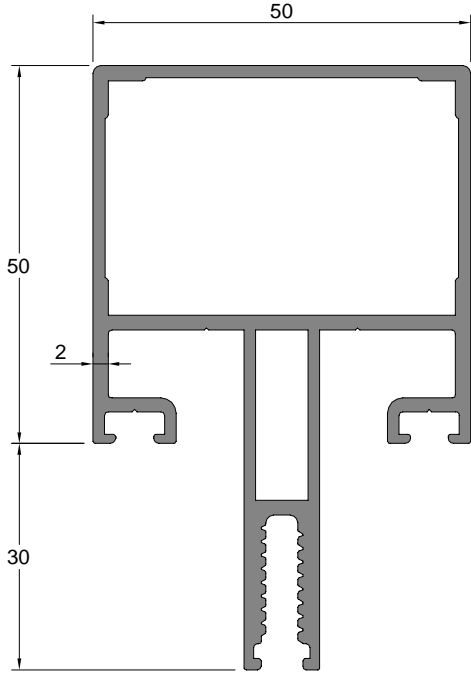

Düey Profili	Profil Kodu	(kg/mt)	Jx cm <sup>4</sup>	Jy cm <sup>4</sup>
VERTICAL PROFILE	5008	1,596	29,72	15,37

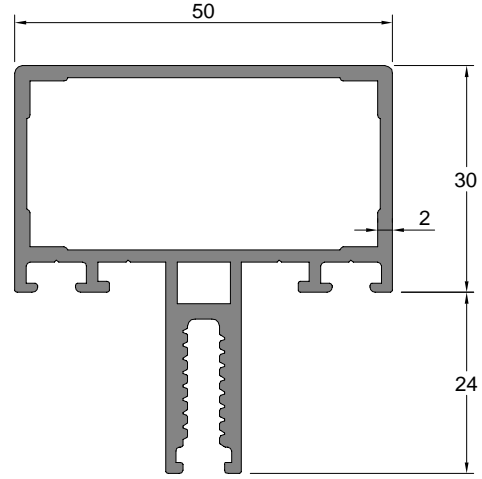

Yatay Profili	Profil Kodu	(kg/mt)	Jx cm <sup>4</sup>	Jy cm <sup>4</sup>
TRANZOM PROFILE	5013	1,150	10,22	9,86

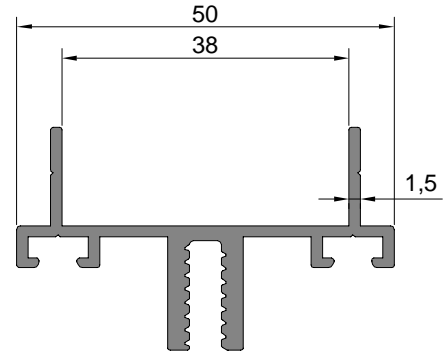

Düey Yatay Profili	Profil Kodu	(kg/mt)	Jx cm <sup>4</sup>	Jy cm <sup>4</sup>
TRANZOM PROFILE	5112	0,617	4,39	0,89

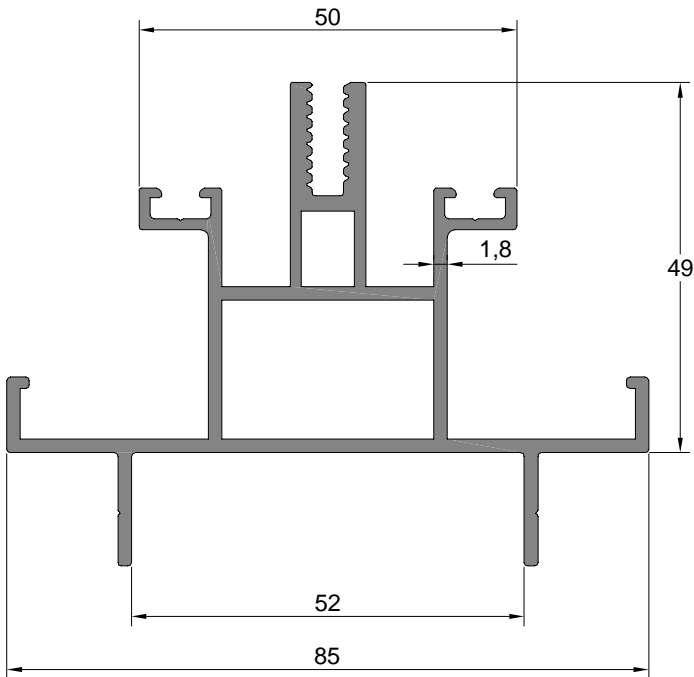

Düey Profili	Profil Kodu	(kg/mt)	Jx cm <sup>4</sup>	Jy cm <sup>4</sup>
VERTICAL PROFILE	5108	1,585	23,97	15,63

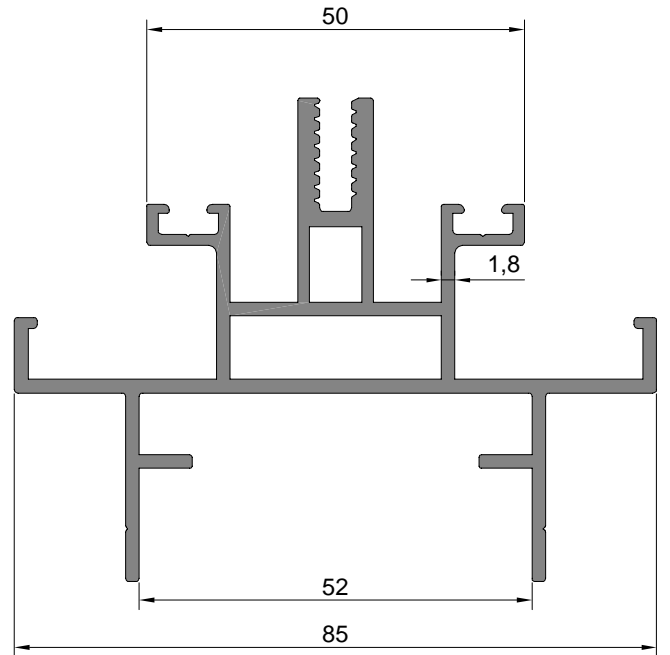

Yatay Profili	Profil Kodu	(kg/mt)	Jx cm <sup>4</sup>	Jy cm <sup>4</sup>
TRANZOM PROFILE	5109	1,653	27,06	12,57

\*\*50 mm'lik çelik karkasaya göre 1 mm'lik mebran kullanılmalıdır.

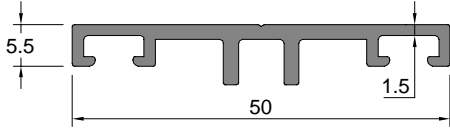

Dü ey Kapak Profili	Profil Kodu	(kg/mt)
VERTICAL CAP PROFILE	Profile Code	weight
	5110	0,390

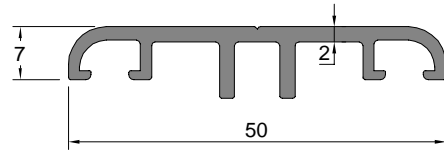

Yatay Kapak Profili	Profil Kodu	(kg/mt)
TRANZOM CAP PROFILE	Profile Code	weight
	5111	0,429

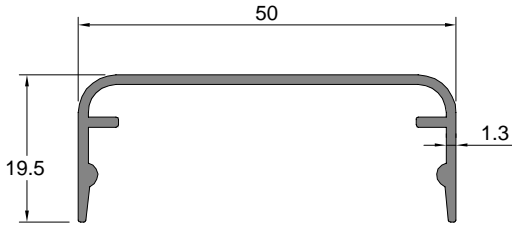

Kapak Profili	Profil Kodu	(kg/mt)
CAP PROFILE	Profile Code	weight
	5046	0,334

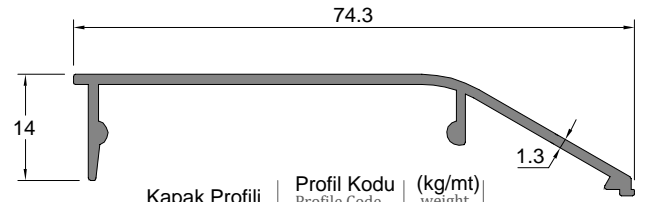

Kapak Profili	Profil Kodu	(kg/mt)
CAP PROFILE	Profile Code	weight
	5047	0,369

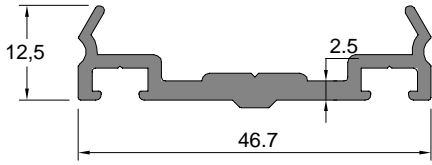

Kapak Altı Profili	Profil Kodu	(kg/mt)
CAP UNDER PROFILE	Profile Code	weight
	5048	0,466

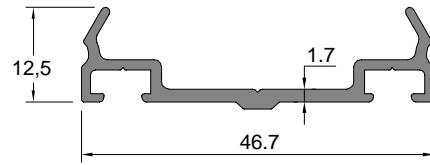

Kapak Altı Profili	Profil Kodu	(kg/mt)
CAP UNDER PROFILE	Profile Code	weight
	7619	0,337

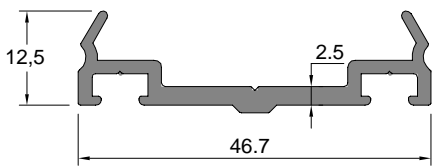

Kapak Altı Profili	Profil Kodu	(kg/mt)
CAP UNDER PROFILE	Profile Code	weight
	5124	0,430

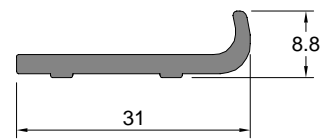

Cam Altı Takoz Profili	Profil Kodu	(kg/mt)
GLASS UNDER WEDGE PROFILE	Profile Code	weight
	5058	0,244

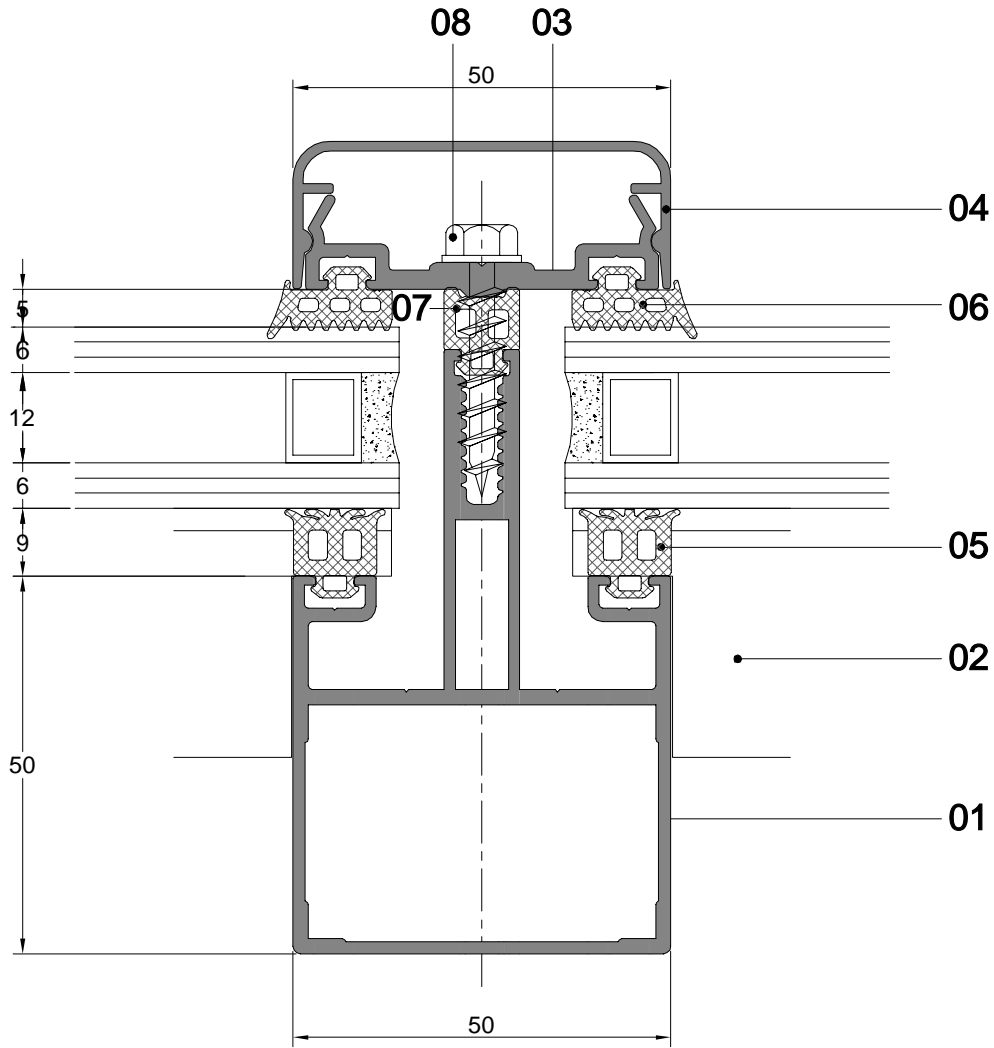
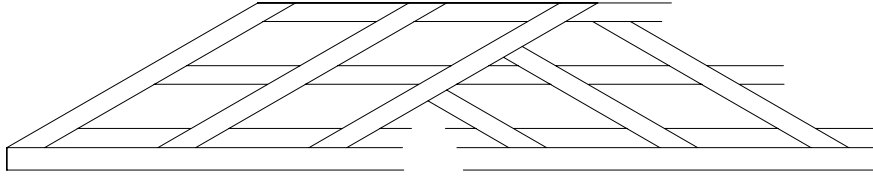

01. DÜ EY PROF L  
02. YATAY PROF L  
03. BASKI PROF L

5008  
5013  
5048

04. DÜ EY KAPAK PROF L  
05. CAM F T L  
06. CAM F T L

5046  
CF 09  
KF.50

07. MESAFE F T L  
08. V DA 5.5x32

MF 08  
YSB-A2

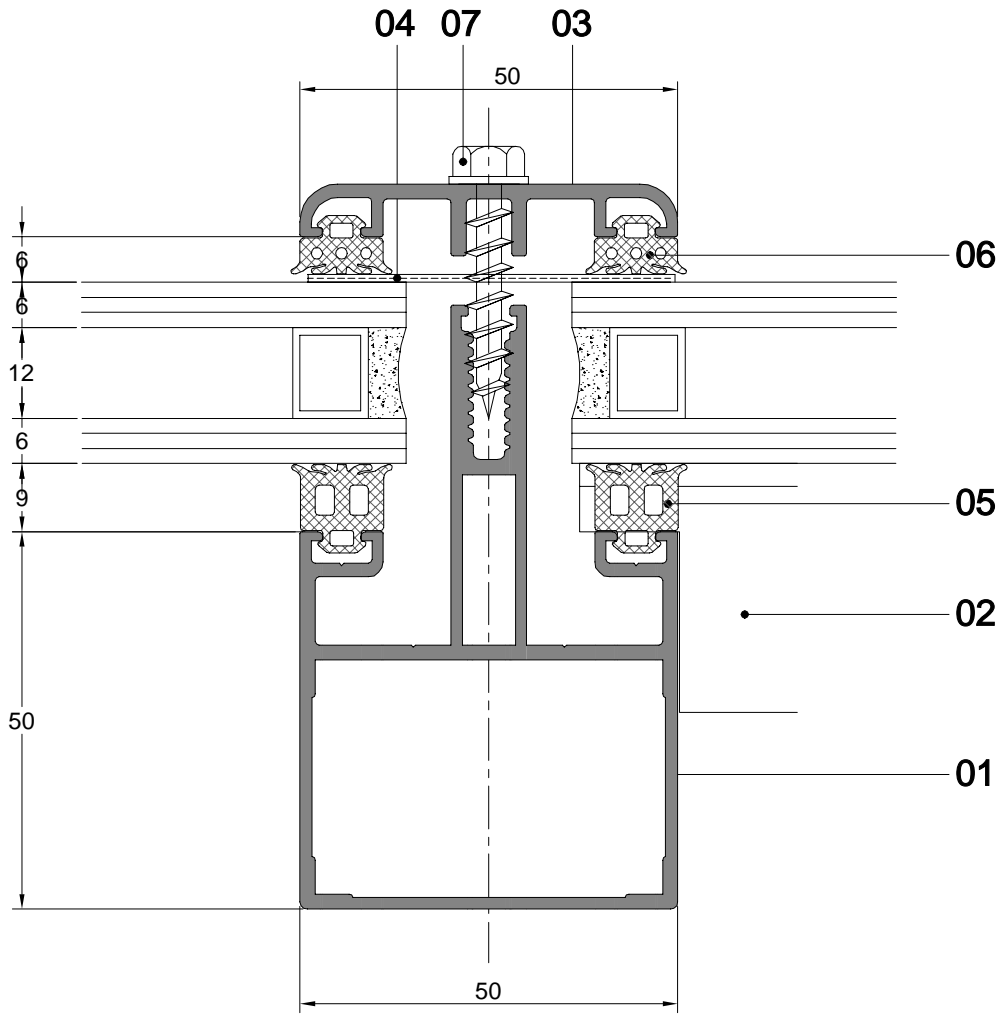
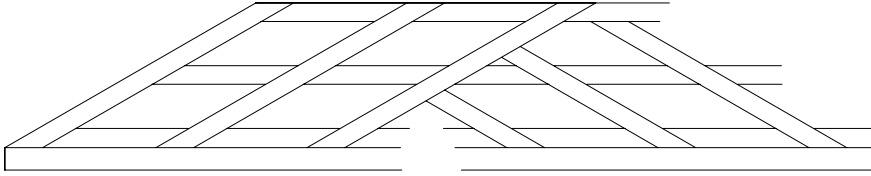

- 01. DÜZEY PROFİL
- 02. YATAY PROFİL
- 03. DÜZEY KAPAK PROFİL

5008  
5013  
5111

- 04. FOLYOLU BUTLANTI
- 05. CAM FİTİL
- 06. CAM FİTİL

CF 09  
CF 05

- 07. VİDA 5.5x32

YSB-A2



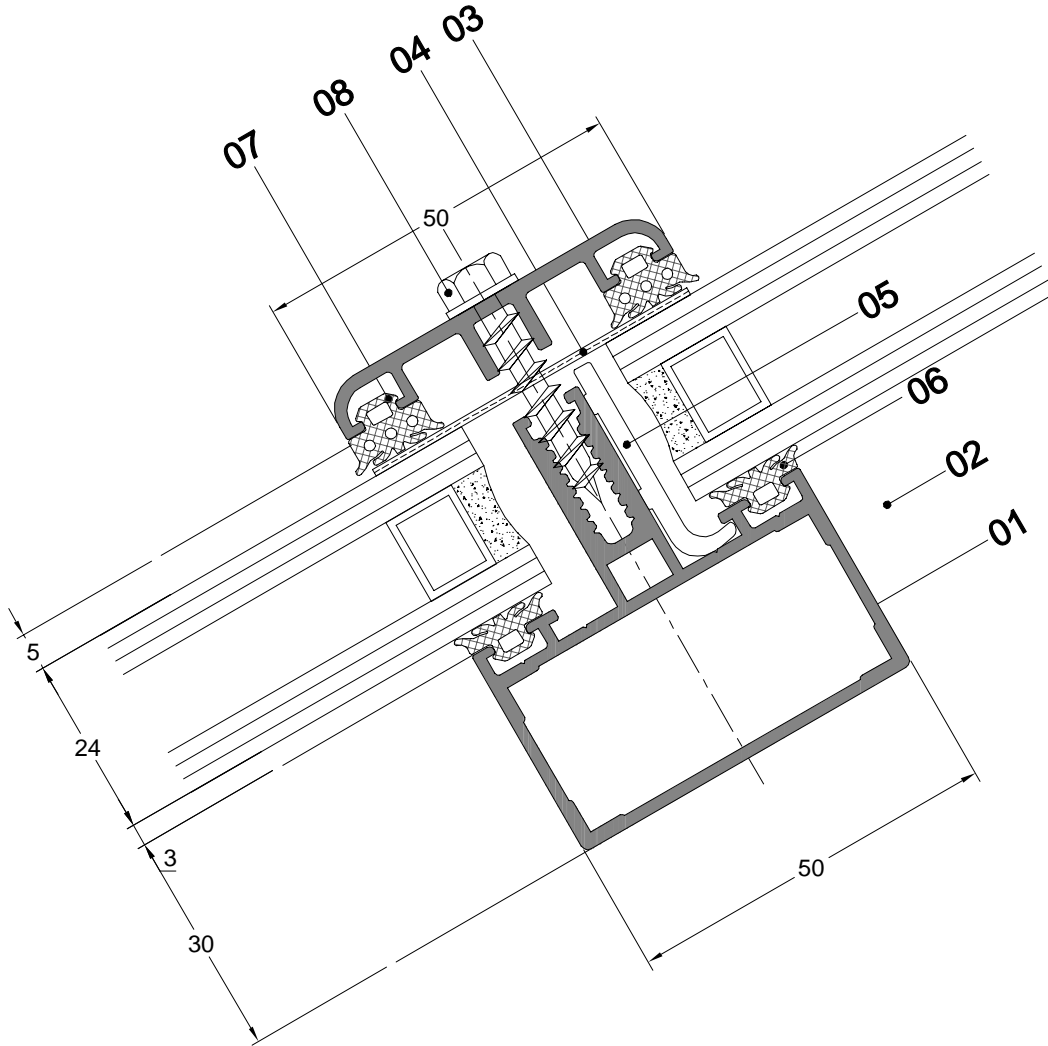
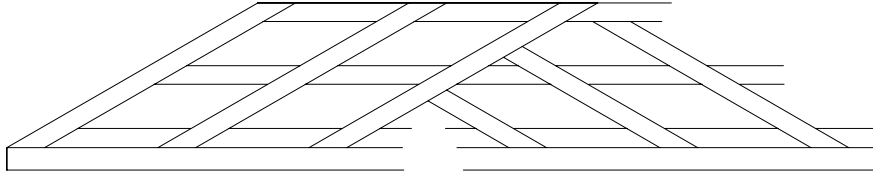

01. YATAY PROF L  
02. DÜ EY PROF L  
03. YATAY KAPAK PROF L

5013  
5008  
5111

04. FOLYOLU BUT L BANT  
05. CAM TAKOZ PROF L  
06. CAM F T L

5058  
CF 03

07. CAM F T L  
08. V DA 5.5x32

CF 05  
YSB-A2

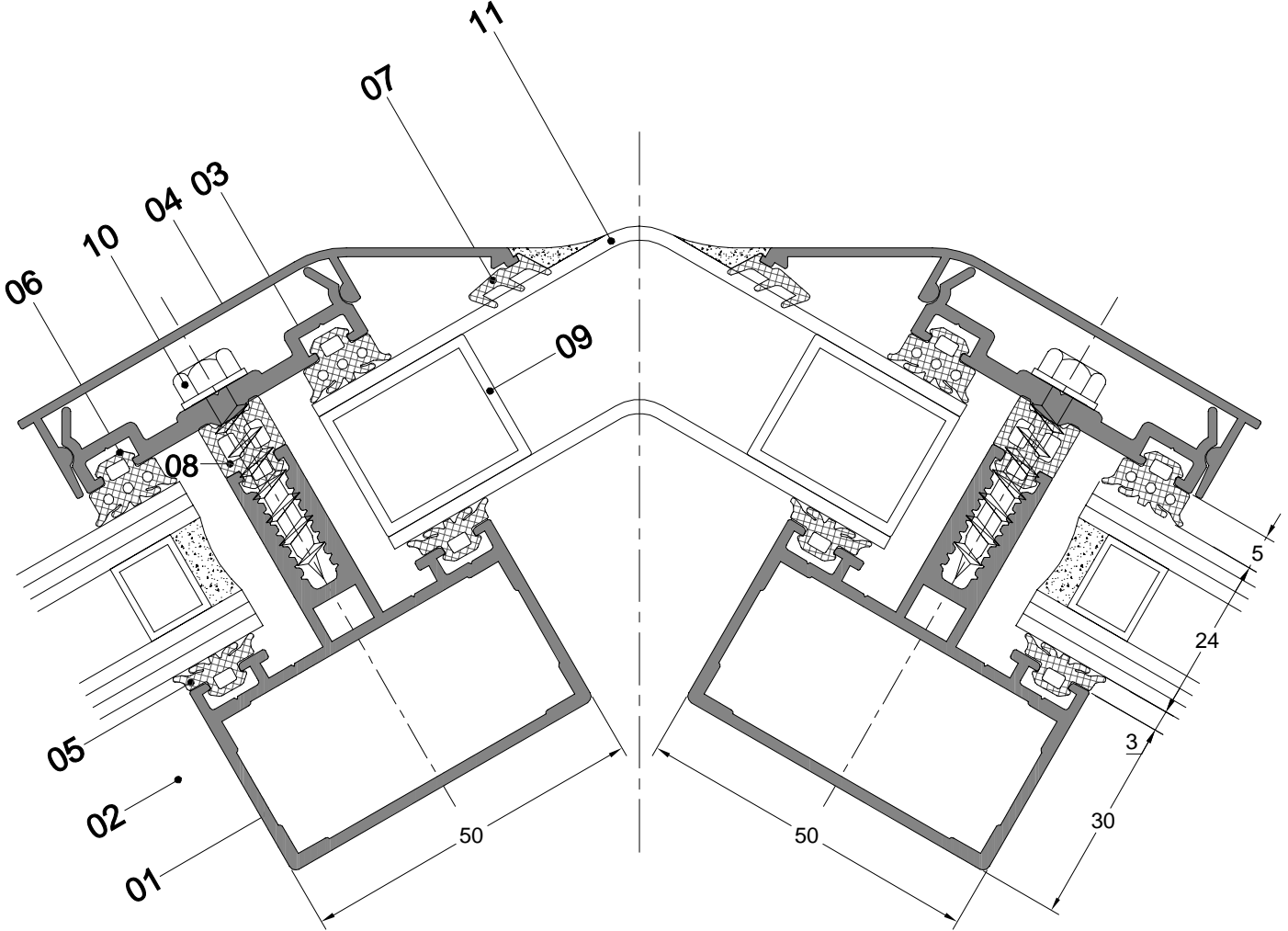
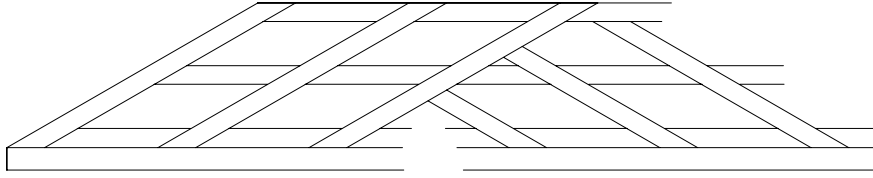

01. YATAY PROF L	5013	05. CAM F T L	CF 03
02. DÜ EY PROF L	5008	06. CAM F T L	CF 05
03. BASKI PROF L	5048	07. Ç CAM F T L	CF 30
04. YATAY KAPAK PROF L	5047	08. MESAFE F T L	MF 08

09. PLAST K KUTU	
10. V DA 5.5x32	YSB-A2
11. ALÜM NYUM LEVHA	2.0 mm

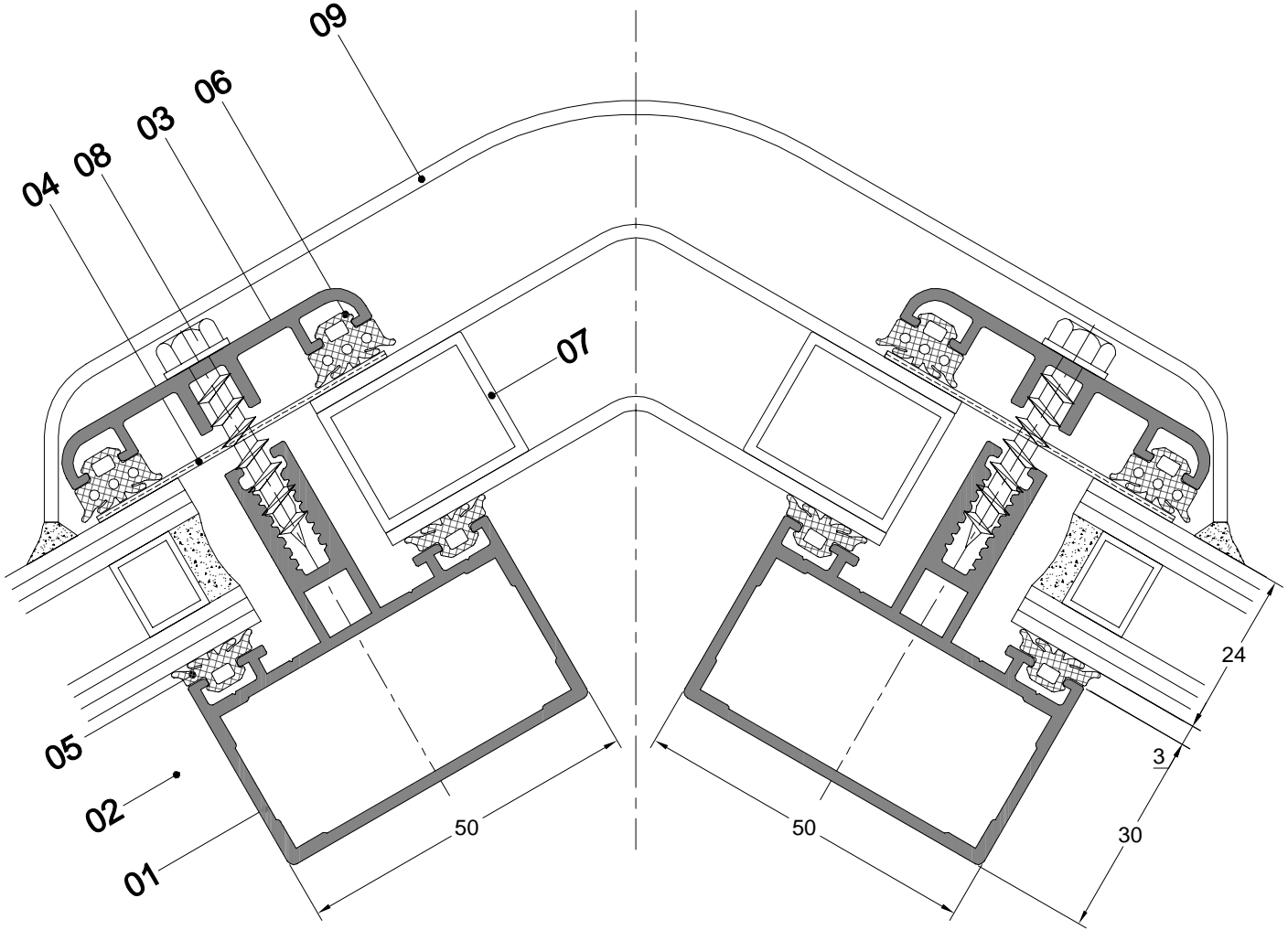
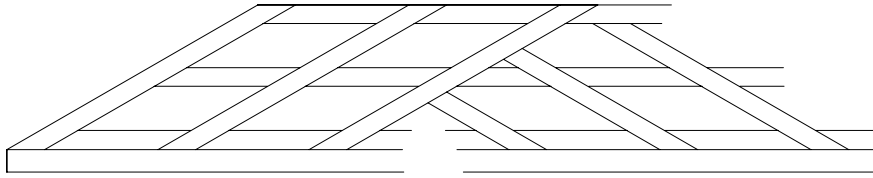

01. YATAY PROF L  
02. DÜ EY PROF L  
03. YATAY KAPAK PROF L

5013  
5008  
5111

04. FOLYOLU BUT L BANT  
05. CAM F T L  
06. CAM F T L

CF 03  
CF 05

07. PLAST K KUTU 20x24  
08. V DA 5.5x32 YSB-A2  
09. ALÜM NYUM LEVHA 2.0 mm

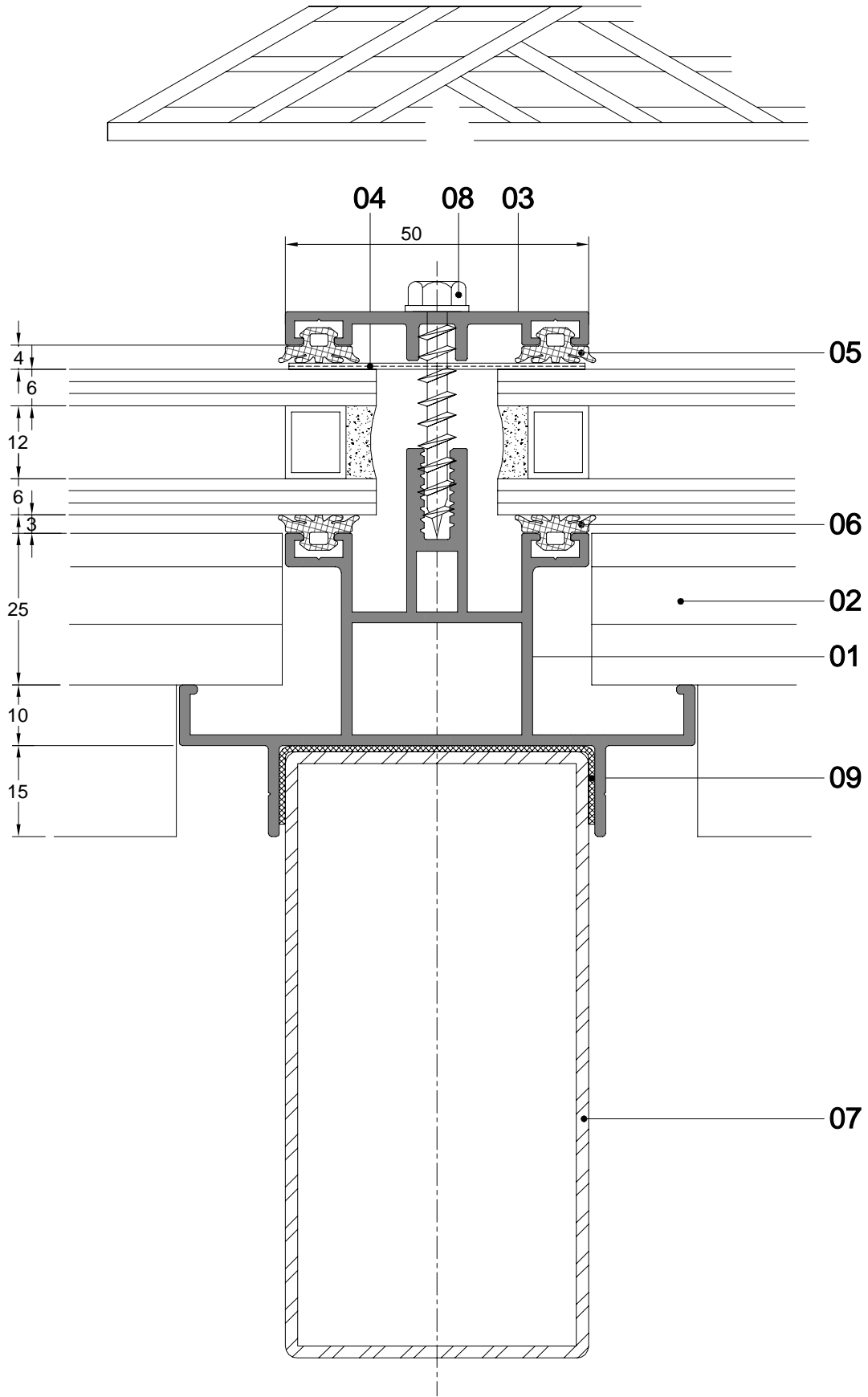

01. DÜ EY PROF L  
02. YATAY PROF L  
03. DÜ EY KAPAK PROF L

- 5108 | 04. FOLYOLU BUT L BANT  
5109 | 05. CAM F T L  
5110 | 06. CAM F T L

- CF 03 | 07. KUTU PROF L 100x50x2  
CF 03 | 08. V DA 5.5x38 YSB-A2  
09. P B BANT

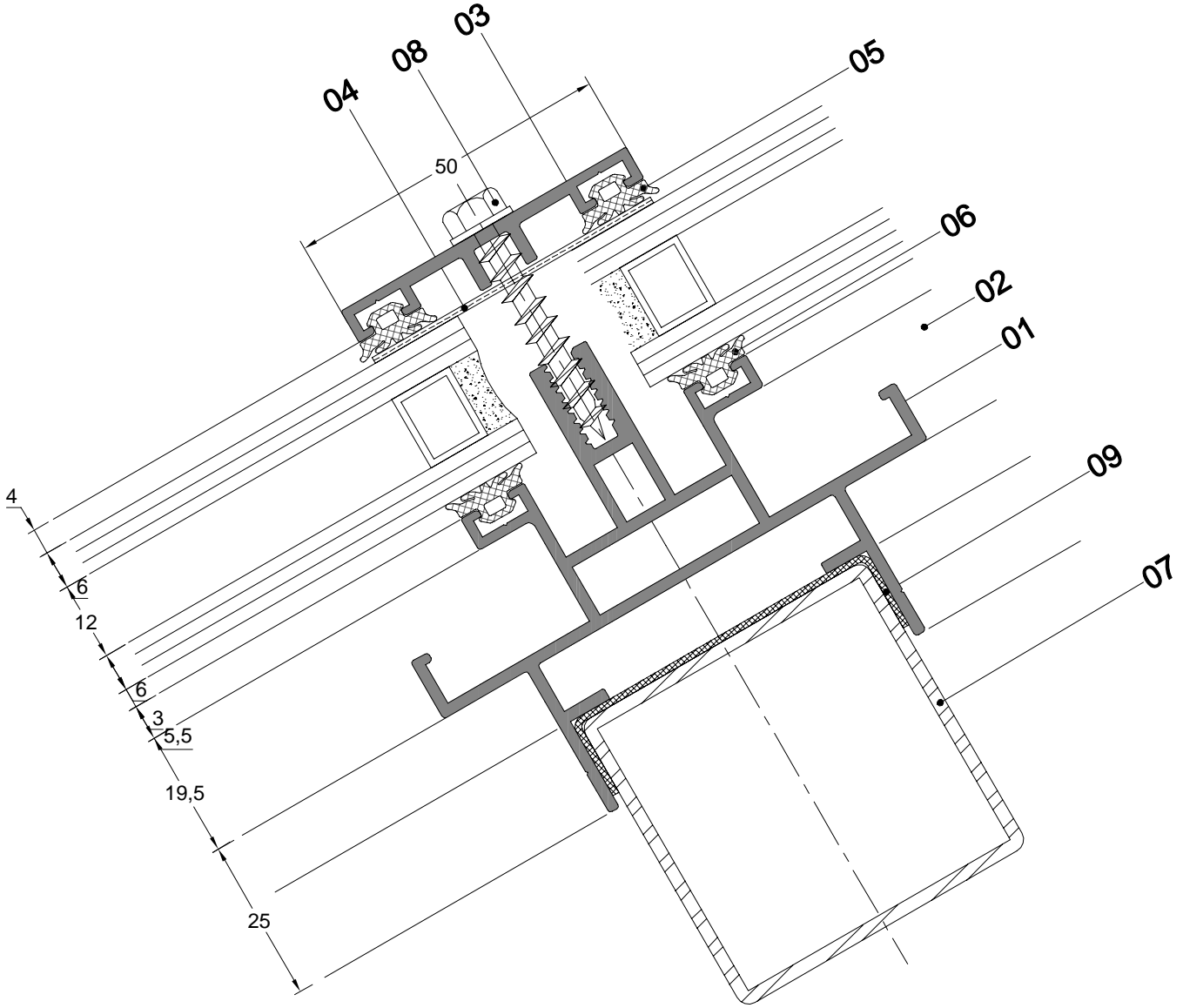
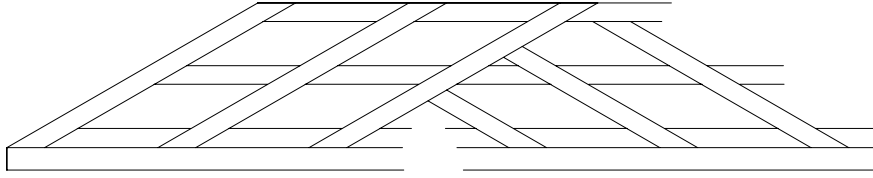

- 01. YATAY PROF L
- 02. DÜZ PROF L
- 03. YATAY KAPAK PROF L

- 5109 04. FOLYOLU BUT L BANT
- 5108 05. CAM F T L
- 5110 06. CAM F T L

- CF 03 07. KUTU PROF L 50x50x2 ÇELİK
- CF 03 08. V DA 5.5x38 YSB-A2
- 09. P B BANT

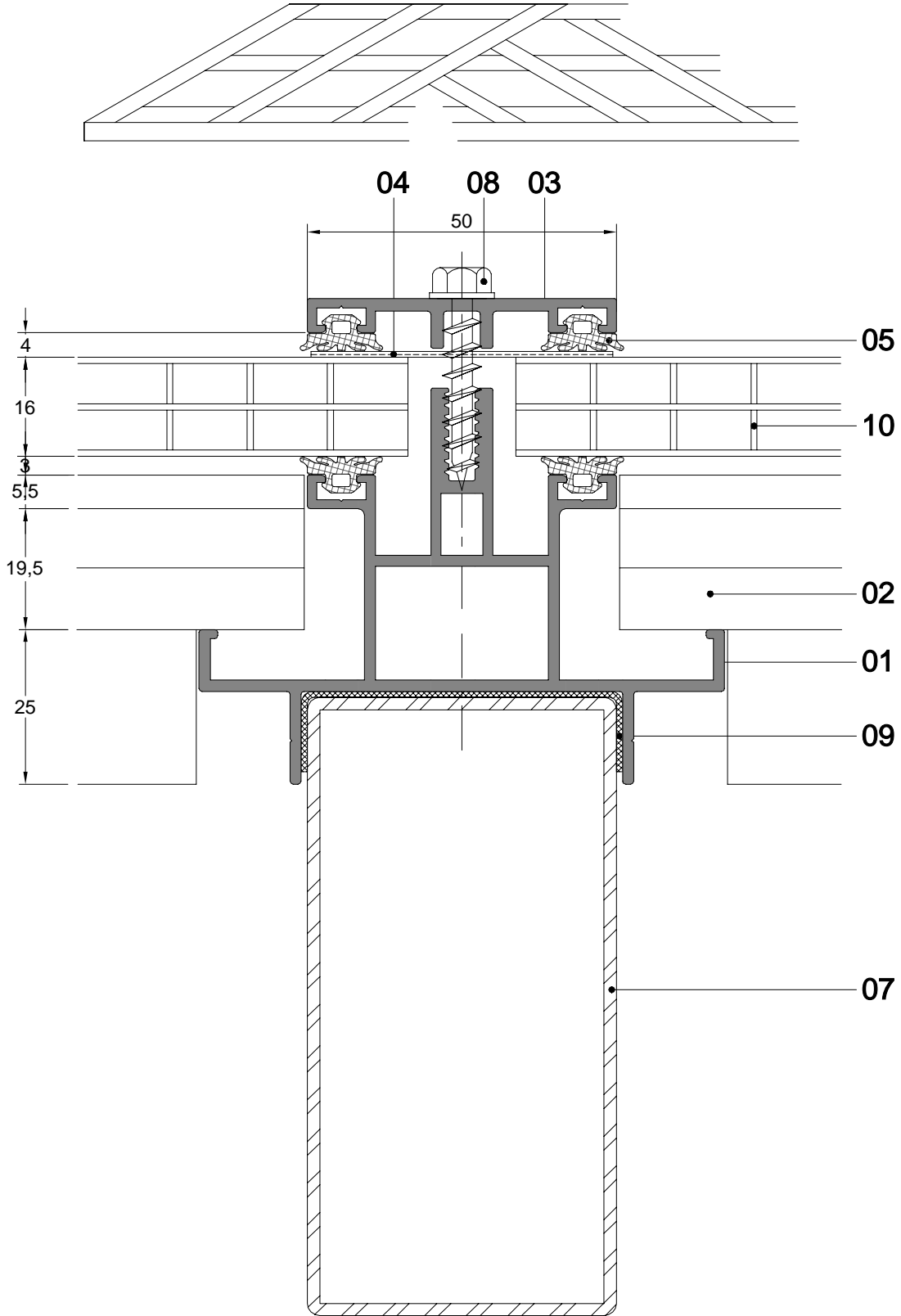

01. DÜ EY PROF L  
02. YATAY PROF L  
03. DÜ EY KAPAK PROF L  
04. FOLYOLU BUT L BANT

5108  
5109  
5110

05. CAM F T L  
06. CAM F T L  
07. KUTU PROF L 100x50x2  
08. V DA 5.5x32

CF 03  
CF 03  
ÇEL K  
YSB-A2

09. P B BANT  
10. LEXAN

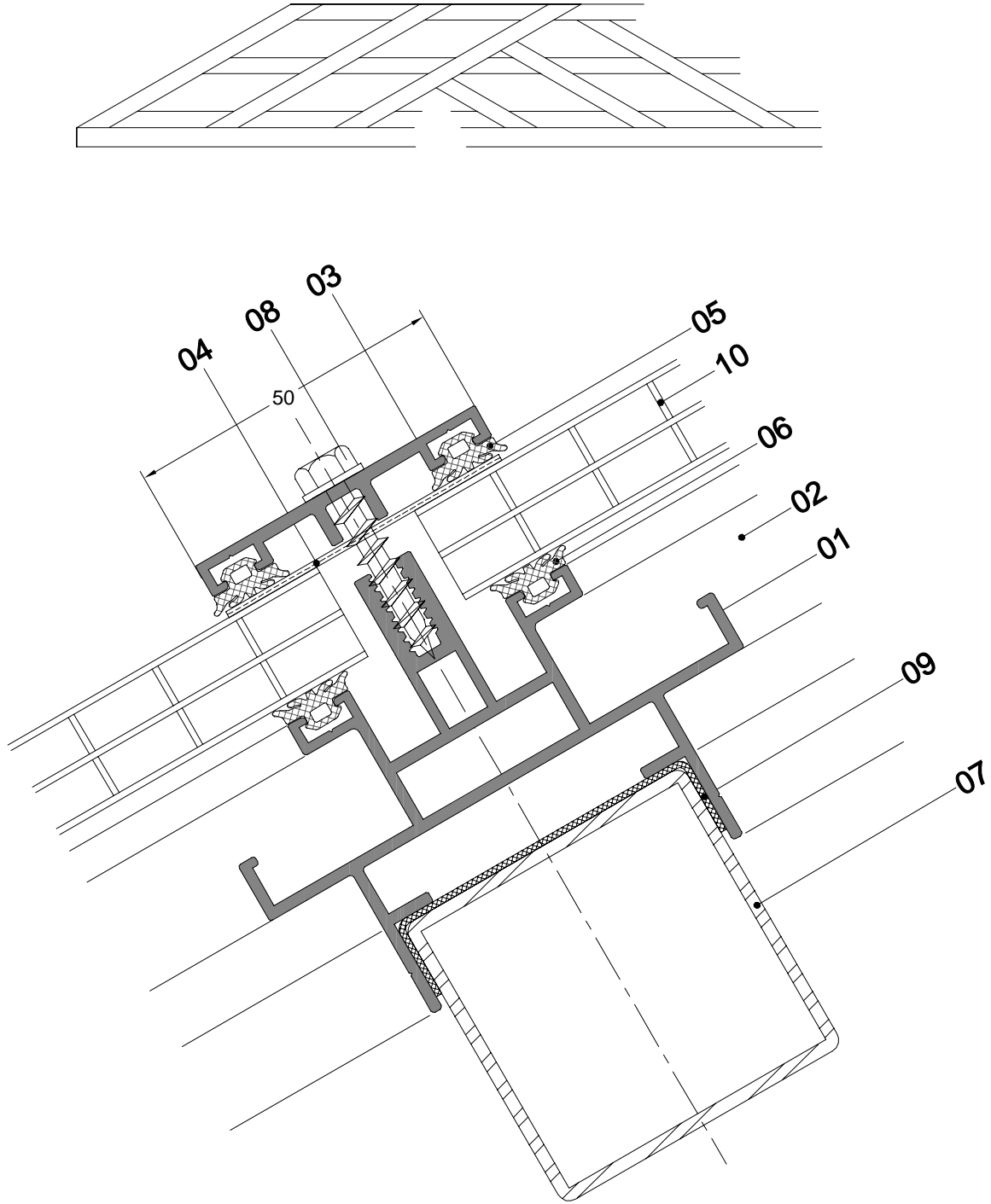

01. YATAY PROF L  
02. DÜ EY PROF L  
03. YATAY KAPAK PROF L  
04. FOLYOLU BUT L BANT

5109  
5108  
5110  
05. CAM F T L  
06. CAM F T L  
07. KUTU PROF L 50x50x2  
08. V DA 5.5x32

CF 03  
CF 03  
ÇEL K  
YSB-A2  
09. P B BANT  
10. LEXAN

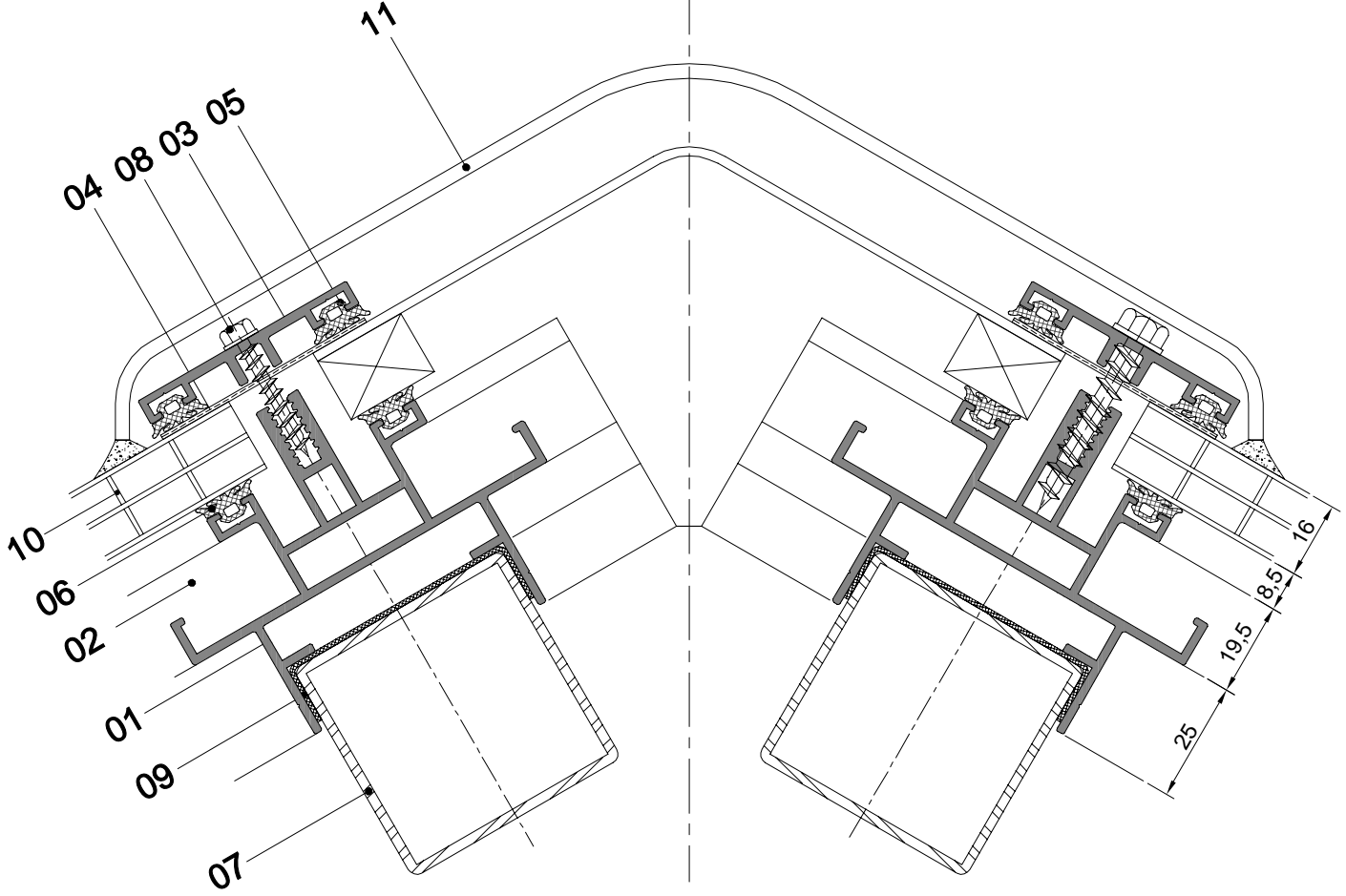
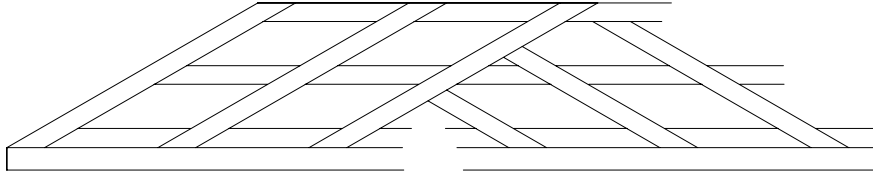

Ölçek : 1/1.5

01. YATAY PROF L  
02. DÜ EY PROF L  
03. YATAY KAPAK PROF L  
04. FOLYOLU BUT L BANT

5109 05. CAM F T L  
5108 06. CAM F T L  
5110 07. KUTU PROF L 50x50x2  
08. V DA 5.5x38

CF 03 09. P B BANT  
CF 03 10. LEXAN  
ÇEL K 11. ALÜM NYUM LEVHA 3.0 mm  
YSB-A2



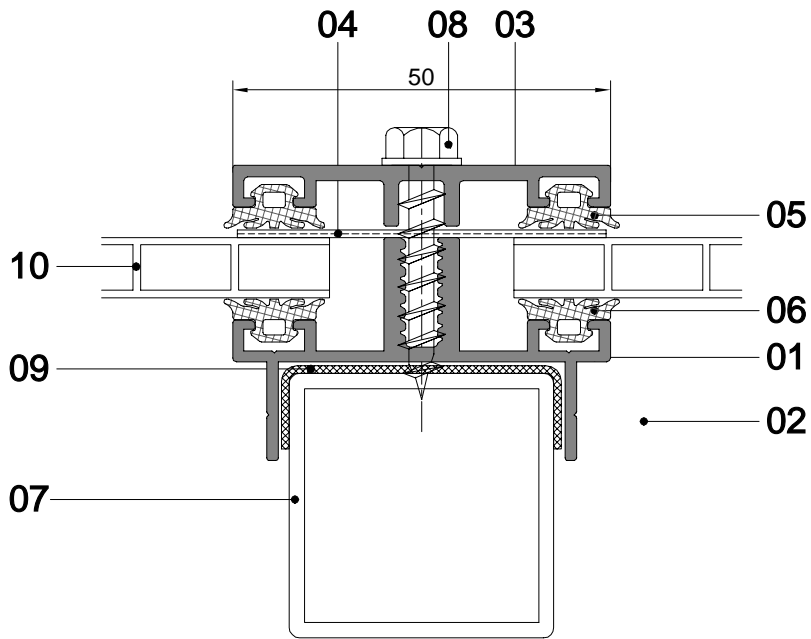
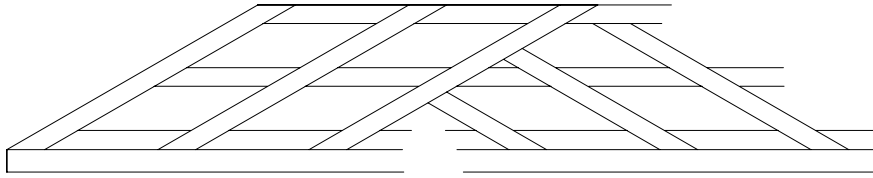

- 01. DÜ EY PROF L
- 02. YATAY PROF L
- 03. DÜ EY KAPAK PROF L
- 04. FOLYOLU BUT L BANT

- 5112 05. CAM F T L
- 5112 06. CAM F T L
- 5110 07. KUTU PROF L 35x35x2
- 08. V DA 5.5x32

- CF 03 09. P B BANT
- CF 03 10. LEXAN
- ÇEL K
- YSB-A2

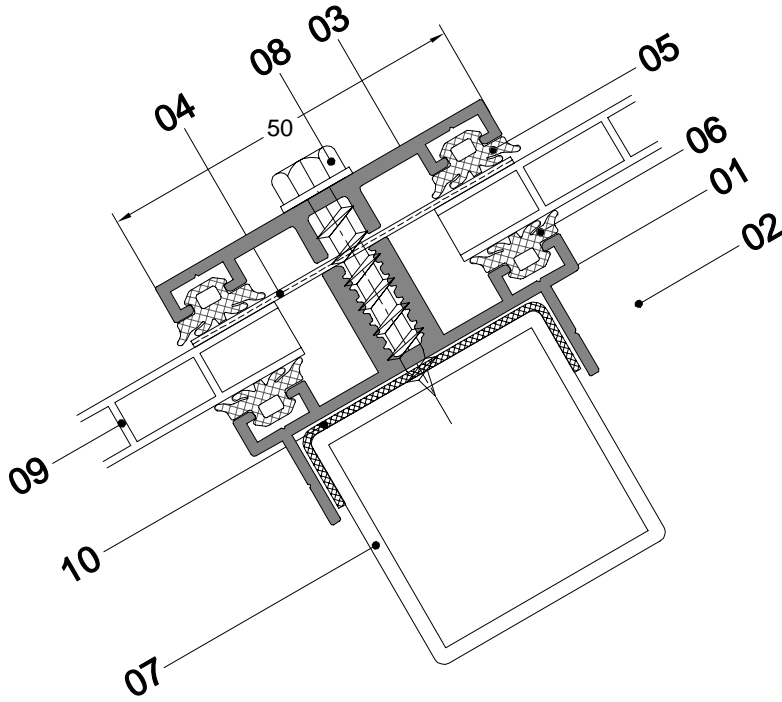
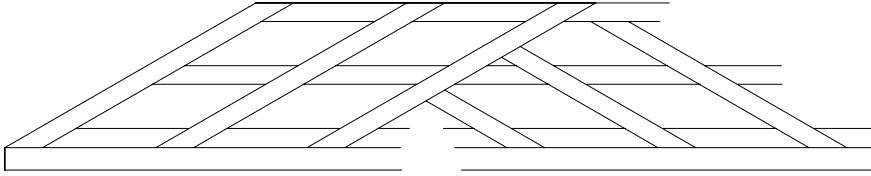

- 01. DÜ EY PROF L
- 02. YATAY PROF L
- 03. YATAY KAPAK PROF L
- 04. FOLYOLU BUT L BANT

- 5112 05. CAM F T L
- 5112 06. CAM F T L
- 5110 07. KUTU PROF L 35x35X2
- 08. V DA 5.5x32

- CF 03 09. LEXAN
- CF 03 10. P B BANT
- ÇEL K
- YSB-A2